

### Main Configuration

- ATS switch ( with intelligent controller )
- ATS communication connector
- Control signal terminals
- Grounding copper bar
- Electrical mounting plate(aluminum zinc coated plate )
- Standard electric cabinet

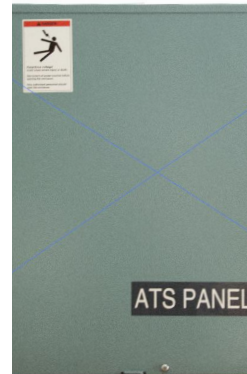

### ATS Main Performance

- Padlock and on-off position indication, reliably realize the isolation of power supply and load.
- Four operating functions:
  - ◇ Emergency manual operation
  - ◇ Electric remote control operation
  - ◇ Emergency disconnect operation under automatic control state
  - ◇ Automatic control operation
- Three working states (I-O-II):
  - ◇ Common closing and standby opening;
  - ◇ Common opening, standby closing;
  - ◇ Common and standby power sources are both disconnected.

### Main Features

1. Intelligent controller uses IC as the control core.
2. Adopte built-in sampling line.
3. Strong anti-interference ability.
4. Full functions, with overvoltage, undervoltage and open phase switching.
5. Double breakpoint horizontal pull mechanism is adopted, which is safe and reliable in switching on and off.
6. The actuating load disconnecting switch is equipped with mechanical interlock.
7. Normal and standby power sources work reliably with non interference.
8. Adopt the zero-position technology, which can be set to zero compulsivly in case of emergency.

### Working Conditions

- Ambient temperature :  $-25^{\circ}\text{C} \sim +70^{\circ}\text{C}$
- Altitude : Below 2000m
- Humidity : Less than 80%

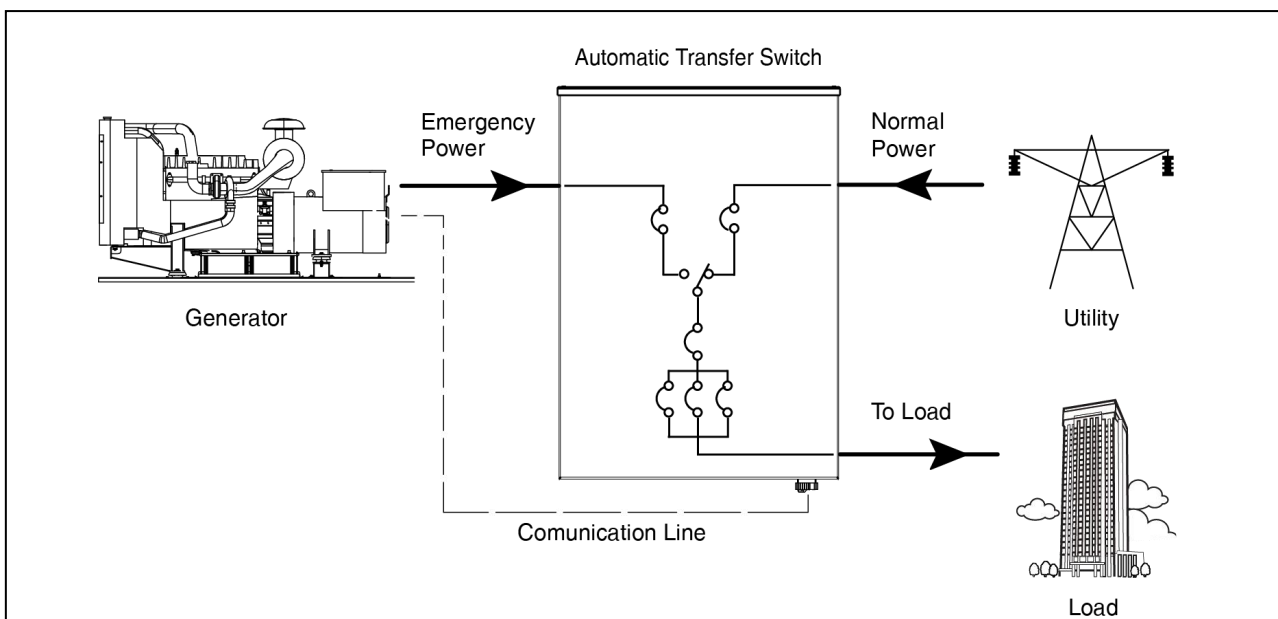

### Main Technical Data

Rated operating current Ie (A)	250A
Rated working voltage Ue	AC400V
Rated control voltage Uc	AC220V, DC24V, 48V
Rated working frequency Fr	50Hz
Rated insulation voltage Ui	690V
Impulse withstand voltage Uimp	8kV
Use category	AC-33B
Short circuit making capacity Icm	17kA
Short time withstand current Icw	10kA/60ms
Switching time	0.6 s

### Overall Dimension

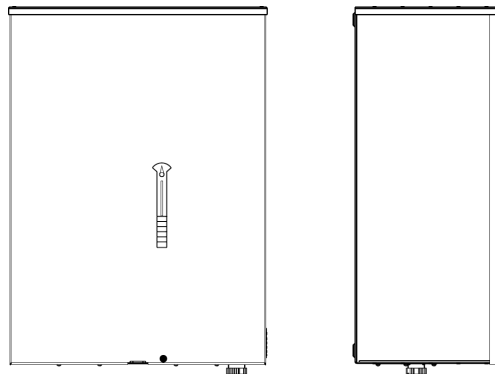

Model	Length	Width	Height	Weight
PC250A	500	280	705	34 kg

Dimension unit: mm

### ATS Communication Diagram

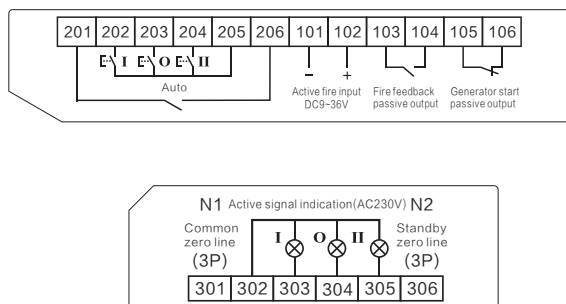

### Design Standard

- IEC60947-1/GB/T 14048-2000 Low-voltage switchgear and controlgear— General rules
- IEC60947-3/GB 14048.3 Low voltage switchgear and controlgear switches, disconnectors, switch-disconnectors and fuse-combination units
- IEC60947-6-1/GB 14048.11 Automatic transfer switchgear equipment